

FIG. 4

FIG. 5

3/4

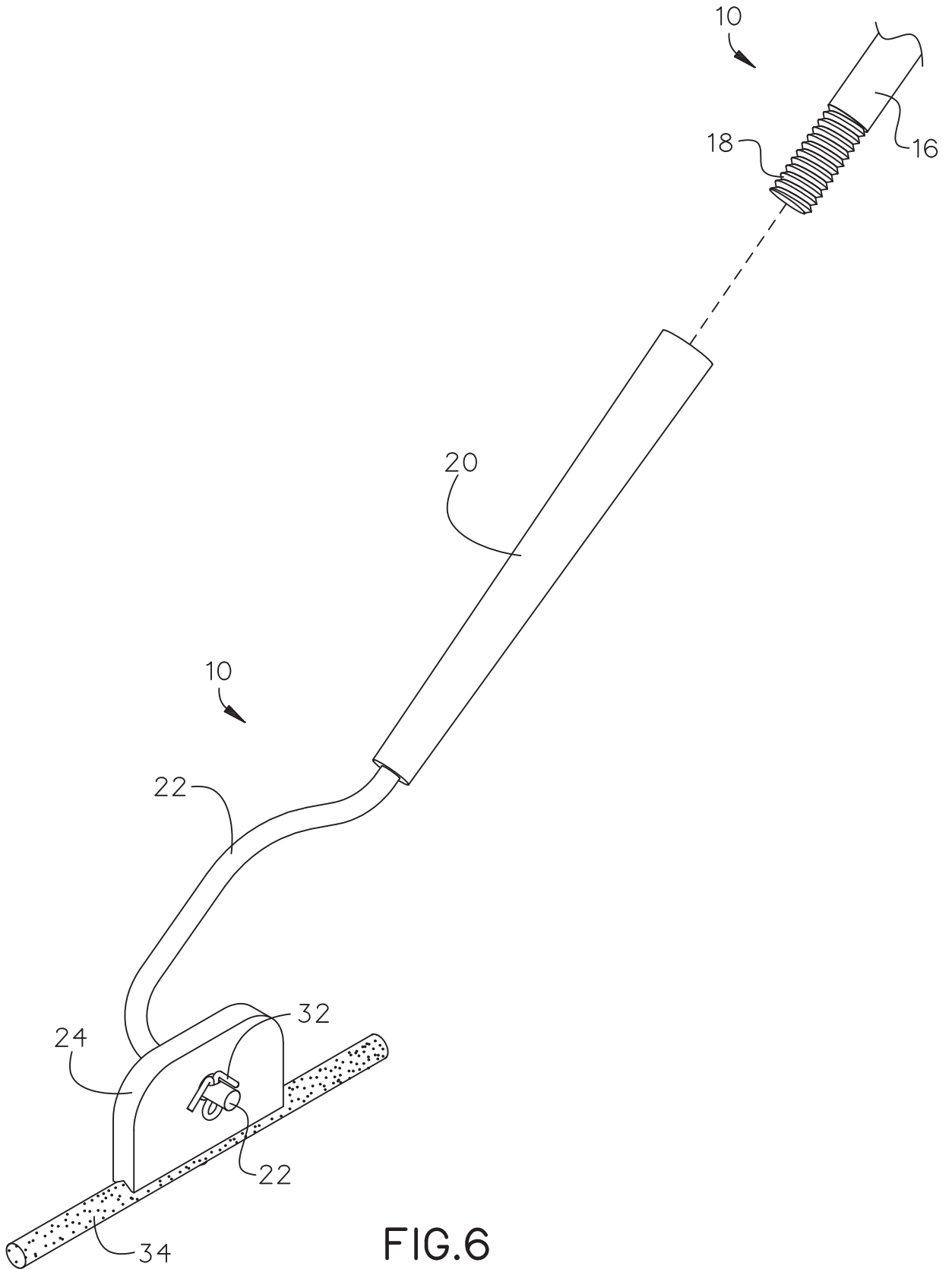

FIG. 6

